



Hydraulic examination couch  
**OVALIA V2 range**  
**OV2-HY-700-125**

**CARINA**  
*Medical*



**CE**  
ISO 9001  
ISO 13485

## TECHNICAL DETAILS

- 2 sections hydraulic examination couch, width 70cm
- Control : One pedal on each side of the couch
- Head rest adjustment in every positions with electric jack
- Flat upholstery with good density 24kg/m<sup>2</sup>, M1 fire retardant class, thickness 5cm
- Equipped with paper roll holder for exam sheet roller on the head side
- Shapped base for ideal cleaning, base colour light grey (RAL 7035)
- On 4 wheels diam. 125mm with one brake on each wheel

## DIMENSIONS

- Width 70cm
- Adjustable height from 48 to 85cm
- Load capacity : 150kg in dynamic

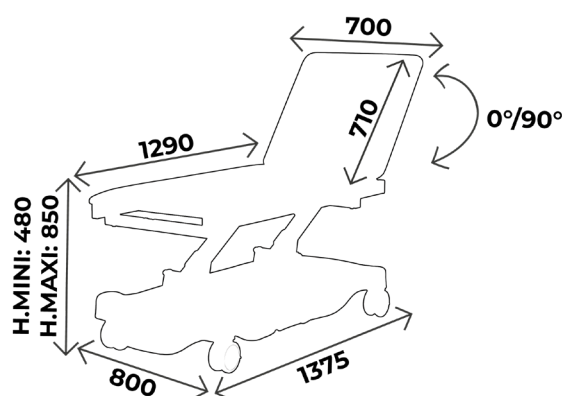

### You may also like :

Ref. **OV2-HY-800-125** : Same as OV2-HY-700-125 but width 80cm



## WHAT YOU NEED TO KNOW

- ✓ Delivery time: 15 days upon receipt of order
- ✓ Warranty : 5 years (1 year for the upholstery)

## ACCESSORIES



**RL-150**  
4 wheels diam. 150mm  
with central brake system



**ACC 76-OVALIA-70**  
Pair of clamps  
for couch width 70cm



**ACC 110POLY**  
Polyurethane blood test splint  
without clamp, the unit



**ACC 110**  
Blood test splint in colour  
without clamp, the unit



**ACC 964**  
Pair of legrests on knee system  
in black polyurethane,  
diam. 14 mm, without clamp



**SLFEMIREPOSE**  
Cover for legrests ACC964  
in upholstery, the unit

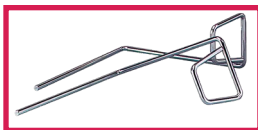

**ACC 105**  
Pair of stainless steel stirrups  
diam. 14mm, without clamp



**ACC 32012**  
Stainless steel infusion stand  
diam. 16mm, 2 plastic hooks,  
without clamp



**ACC 514-UNIVERSE**  
Plastic protection cover  
for all couches



**ACC 832**  
Face hole with plug cushion



**ACC 76C**  
Unit clamp to fix infusion stand  
diam. 16mm

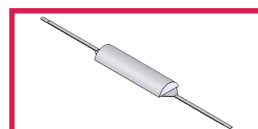

**ACC 54002**  
Half moon headrest width 70cm  
fire retardant M1 class



**ACC OVALIA02**  
Pair of stainless steel rails 25x10  
length 1500mm for OVALIA V2  
2 sections



**ACC BARRILITOV02**  
Pair of retractable security side  
rails for couch width 70cm



**ACC-CAPOT**  
Base colour in a different colour  
than the standards light grey  
available in different colours



**ACC TETERGO**  
Ergonomic headrest

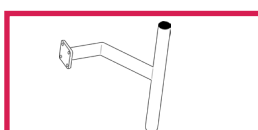

**ACC FEMINA01**  
Coloscope holder

# UPHOLSTERY'S COLOURS

Fire retardant  
upholstery, M1 class

For the upholstery colours, you can choose between the Classic and Urban range  
Be careful ! Urban colours **with extra value**

## *Upholstery : Classic range*



Arno



Garonne



Potomac

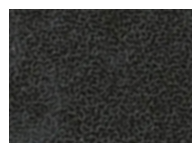

Amour



Mississippi

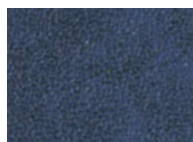

St Laurent



Rhône

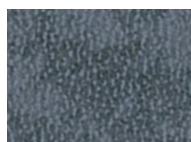

Missouri



Seine

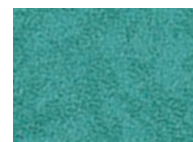

Amazone

## *Upholstery : Urban range*



Abysses



Cendre



Origan



Géranium



Réglisse



Prune

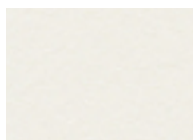

Perle

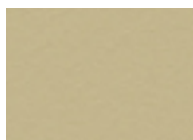

Ficelle

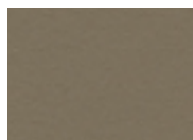

Terre

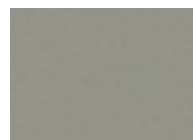

Béton

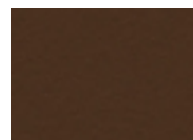

Chataigne

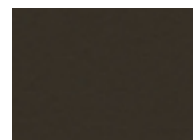

Chocolat

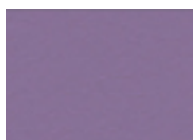

Pensée



Pétrole



Turquoise



Granny



Absinthe



Ananas



Orange



Fuschia



Tomate

# BASE COLOURS

The entire OVALIA V2 range has a light grey (RAL 7035) cover as standard  
Possibility to change the colour of the cover **with an extra charge (option ACC CAPOT)**

## *Base colour*

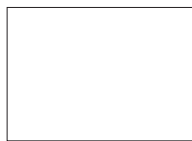

RAL 9003

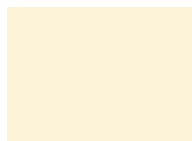

RAL 1013

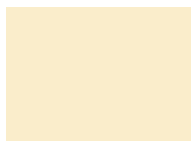

RAL 1015

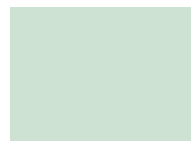

RAL 6019



RAL 6033



RAL 6000



RAL 5017



RAL 5002



RAL 5000

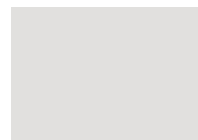

RAL 7035



RAL 7016

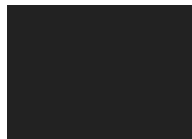

RAL 9005



RAL 1018



RAL 3020



RAL 3003

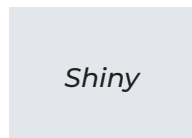

*Shiny*

SILVER



# MAINTENANCE GUIDE

## **DAILY MAINTENANCE**

Upholstery : Cleaning with soapy water only (no solvents), can be disinfected with products such as Phagosept Spray, Salvanios pH10 at 0.75% and Anios Surfaces Hautes, without abrasive material

Base : cleaning with soapy water only (no solvents) without abrasive materials

## **WARRANTY**

Mechanical/ electrical part : 5 years

Upholstery : 1 year



**CONTACT**

**CARINA**  
*Médical*

Parc d'entreprises Visionis  
278 rue de l'industrie  
01090 GUÉREINS- FRANCE

**COMMERCIAL DEPARTMENT**

Tél : +33(0)4 74 66 69 49  
Fax : +33(0)4 74 66 69 50  
[export@carinamedical.com](mailto:export@carinamedical.com)